

# Sanitary partition wall type SVF30 JUMP

Cubicle system made of 30 mm chipboard

**schäfer**<sup>®</sup>  
Trennwandsysteme



Stylish and elegant partitioning.



BEFORE WE  
EXPECT TRUST FROM  
OUR CUSTOMERS,  
WE PROVIDE EVIDENCE  
*that's us!*

## ENVIRONMENT & SUSTAINABILITY *that's us!*

Sustainable management and careful use of resources are a matter of course for us and part of our corporate philosophy. This basic idea is consistently integrated and lived in our work processes. We are proud to be the first certified manufacturer of partition systems and lockers in Germany to operate according to the FSC™ and PEFC guidelines.

### PEFC - registered

We pay attention to a sustainable supply chain in which our products are procured under ecological, economic and socially just aspects.

### FSC™ - certified

As the first certified manufacturer in the area of partition systems and lockers in Germany, we make an active contribution to the protection of our earth with this future-oriented procurement method. We supply almost our entire range from sustainable wood in accordance with the specifications of the FSC™.



*On request  
the products are  
available with  
FSC™ certification*

## TÜV NORD GS TESTED SAFETY *that's us!*

Tested and certified by TÜV NORD these products meet the requirements of the Product Safety Act ProdSG § 21  
Registration No. 44 329 14148802



## MADE IN GERMANY *that's us!*

Our products are manufactured for you at the company site in Horhausen, Rhineland-Palatinate. This is the only way we can guarantee the high quality standards we set for our products.



## PREQUALIFIED *that's us!*

We are registered in the list of prequalified construction companies with the number 010.049740, proving that we are qualified for the products and services we offer.



## INNOVATIVE & DESIGN-ORIENTED *that's us!*

With our design-oriented and innovative products, we convince not only our customers, but also national and international committees.



reddot winner 2021





## Floating toilet partitions.

The use of recessed supports and a recessed headrail gives a floating impression to the toilet partition wall SVF30 JUMP. This ensures a certain lightness and a lot of elegance in the sanitary room. A play of colours allows countless design possibilities and with motif prints, every partition becomes unique. SVF30 JUMP is ideal for the implementation of individual room concepts in dry WC rooms.



#### Interesting facts about SVF30 JUMP

##### WC partition walls made of 30 mm thick chipboard with ABS strips

- Recessed supports and headrail give a floating look
- Floor clearance ensures a quick and effective cleaning
- ABS strips in the same colour as the panels
- Wall connections are done as shadow gap
- Hardware made of anodized aluminium
- Flush fitted front on the outside of the cubicle
- Easy to clean and maintenance construction
- Suitable for dry rooms
- Large variety of decors and colours
- System will be produced acc. to the building site dimension







(1)

**(1)**  
**Privacy screens made of 13 mm solid grade laminate**

- Wall-mounted privacy screens
- Revolving edge is always black
- Installed with durable aluminium holders
- Waterproof
- Wall-mounted structures without bottom support feet are particularly hygienic, since floor cleaning can then be faster and more efficient
- Wide range of colors available
- Motif prints are optionally available
- Privacy screens will be produced acc. to the building site dimension

**(2) + (3)**  
**Privacy screens made of 30 mm thick chipboard**

- Wall-mounted privacy screens
- ABS strips and panels in the same colour
- Installed with durable aluminium holders
- Wall-mounted structures without bottom support feet are particularly hygienic, since floor cleaning can then be faster and more efficient
- Wide range of colors available
- Motif prints are optionally available
- Privacy screens will be produced acc. to the building site dimension



(2)



(3)



(1)

**Handrail for toilet partition type SVF30 JUMP**

- Matt, natural anodised
- Very easy to clean
- Integrated Free/engaged indicator (4)
- Emergency opening located below – allows the locked door to be opened from the outside (5)
- Optional available with LED
- Optional energy-saving LED strip shows the locking status clearly visible
- Very good grip, because of the body-friendly shape

**Possible Variation:**

**(1)**

- Handrail adapted to the door length, always until the top edge of the door
- Optional available: in combination with a LED strip

**(2)**

- Handrail 55 x 1.150 mm
- Optional available: in combination with a LED strip

**(3)**

- Handrail 55 x 500 mm
- Optional available: in combination with a LED strip



(2)



(3)



## Features type SVF30 JUMP

### Head rail:



- Head rail recessed by 150 mm behind the front wall
- Aluminium brackets and angles ensure a stable construction

### Supports:



- Dividing wall with recessed aluminium support
- Support holder made of anodised aluminium
- Stabilisation of the front elements by means of T-connectors under the dividing wall and front element, tightly screwed

### Hinges:



- Stainless steel hinge with high-performance polymer
- Treads guarantee absolute freedom from maintenance and a silence closing of the door



- Stainless steel rising hinge
- Doors with self-closing hinges are optionally available



- Aluminium hinge
- Running surface made of high-performance polymer
- Optionally with or without self-closing function
- Optionally available



## Variations of accessories type SVF30 JUMP

### Hardware:



Aluminium  
door handle  
Schäfer AL7050



Stainless steel  
door handle  
Schäfer ES6050



Nylon  
door handle\*  
Schäfer N8051



Aluminium  
one hand door knob  
INSAFE



Aluminium  
push handle SLIDESAFE

[To the handrail configuration online tool >](#)

[To the push handle SLIDESAFE >](#)

[To the one hand door knob INSAFE >](#)

[To the sanitary accessories >](#)

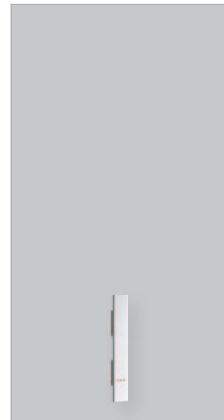

Aluminium handrail  
55 x 500 mm  
Schäfer ALGS1

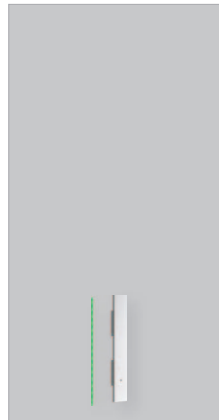

Aluminium handrail  
with LED strip  
55 x 500 mm  
Schäfer ALGS1 LED

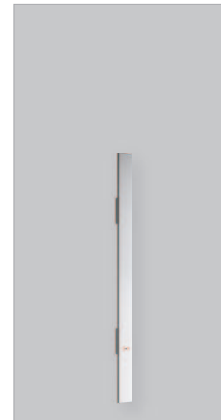

Aluminium handrail  
55 x 1.150 mm  
Schäfer ALGS2

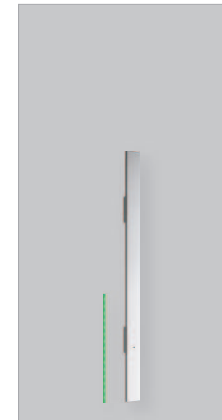

Aluminium handrail  
with LED strip  
55 x 1.150 mm  
Schäfer ALGS2 LED

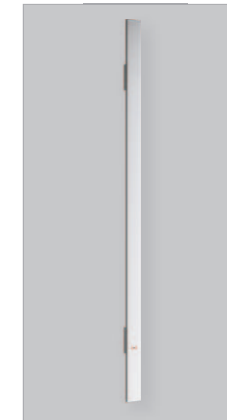

Aluminium handrail,  
adapted to the door  
length, always until the  
top edge of the door  
Schäfer ALGSV

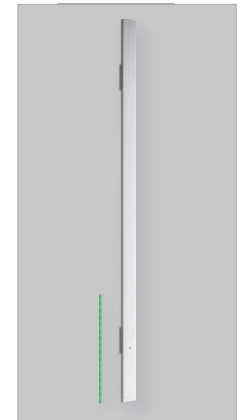

Aluminium handrail with  
LED strip, adapted to the  
door length, always until  
the top edge of the door  
Schäfer ALGSV LED

### Buffer and hooks:



Aluminium buffer  
Schäfer AL7015



Stainless steel buffer  
Schäfer ES6015



Nylon buffer\*  
Schäfer N8015



Aluminium hook  
Schäfer AL7011



Stainless steel hook  
Schäfer ES6011



Nylon hook\*  
Schäfer N8010

\* All nylon finishes are available in  
RAL 9010 and RAL 7038

## Accessories for type SVF30 JUMP BLACKLINE

Fittings from the BLACKLINE design series can be selected as an option for type SVF30 JUMP.



BLACKLINE  
aluminium one-hand door knob INSAFE  
with clearly visible free-occupied indicator



BLACKLINE  
stainless steel door handle  
with free-occupied locking device and emergency  
opening slot on the outside of the cubicle



BLACKLINE  
aluminium door buffer,  
invisible fixation  
Schäfer AL7015S



BLACKLINE  
aluminium hook  
Schäfer AL7011S



BLACKLINE  
aluminium hinge  
with self-closing function



**BLACKLINE**

## Colours type SVF30 JUMP

### Panels:



1001  
Weiß

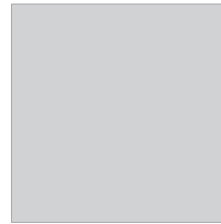

1002  
Silbergrau



1004  
Anthrazit



1005  
Rot



1006  
Limonengrün



1007  
Wasserblau

### ABS strips:

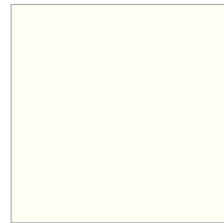

1001  
Weiß

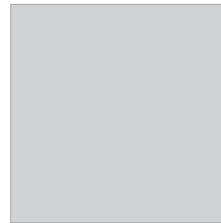

1002  
Silbergrau



1004  
Anthrazit



1005  
Rot



6001  
Goldgelb



1006  
Limonengrün



1007  
Wasserblau



6002  
Ultramarinblau

### Profiles:

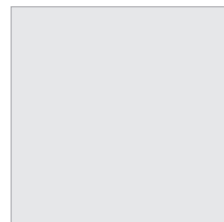

E6/EV1  
Eloxiert

In the option with laminated panels (type SVF30S), the colours white (3001), anthracite (3004) and black (3009) are available.

Special colours for panels, ABS strips and profiles in all RAL colours and special accessories are available upon request. Ask us!

There may be a difference between printed colours and real colours.

## Technical design of cubicle system type SVF30 JUMP

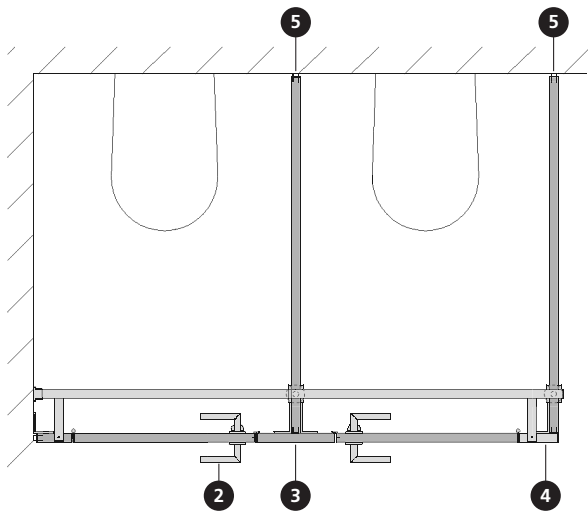

Because of the floating system, a stable wall connection of the front elements is essential. Please note our technical sheet for details.

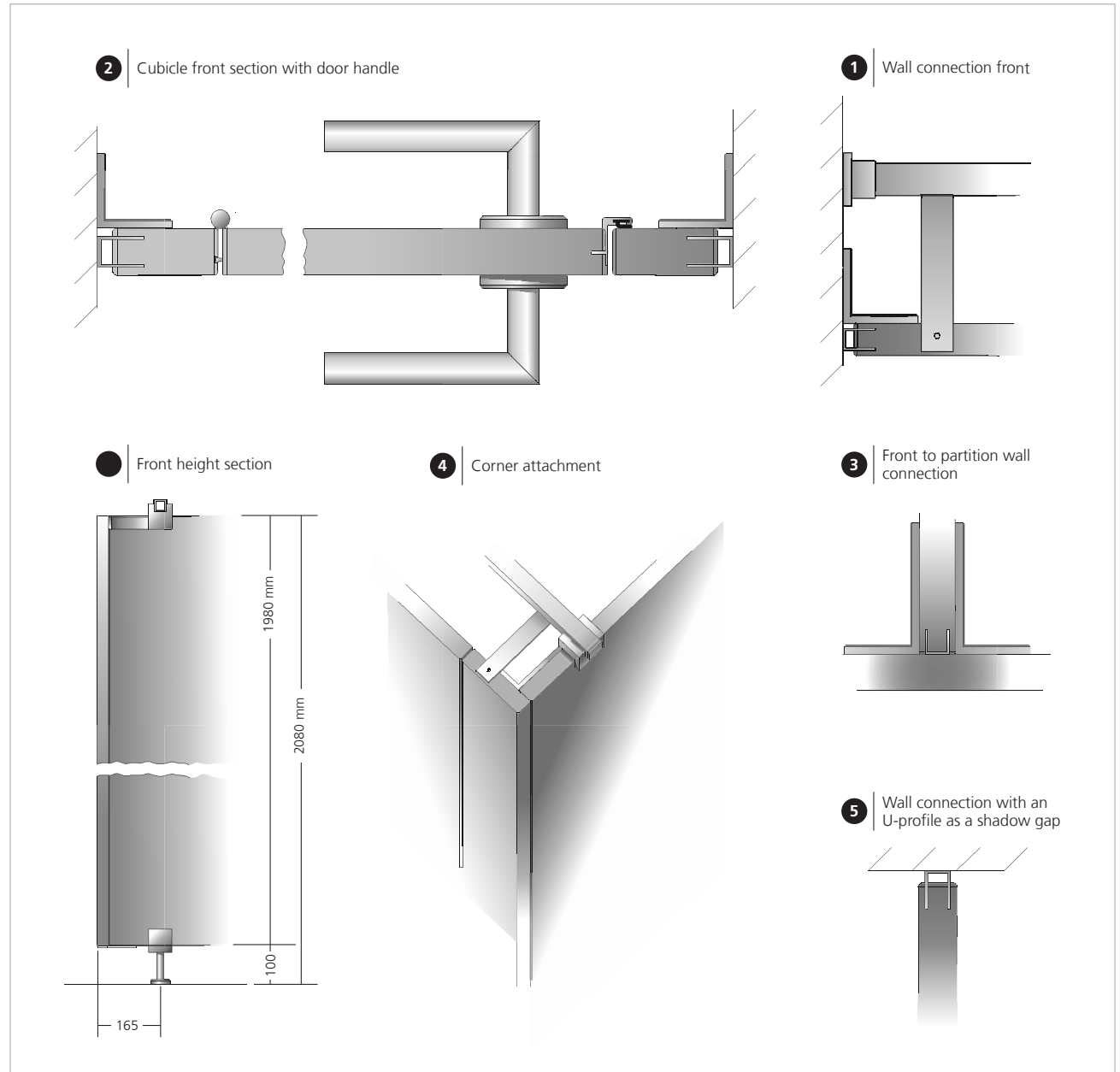

We reserve the right to make technical alterations.

